

Ideas for postpress. Stahlfolder fold type catalog.

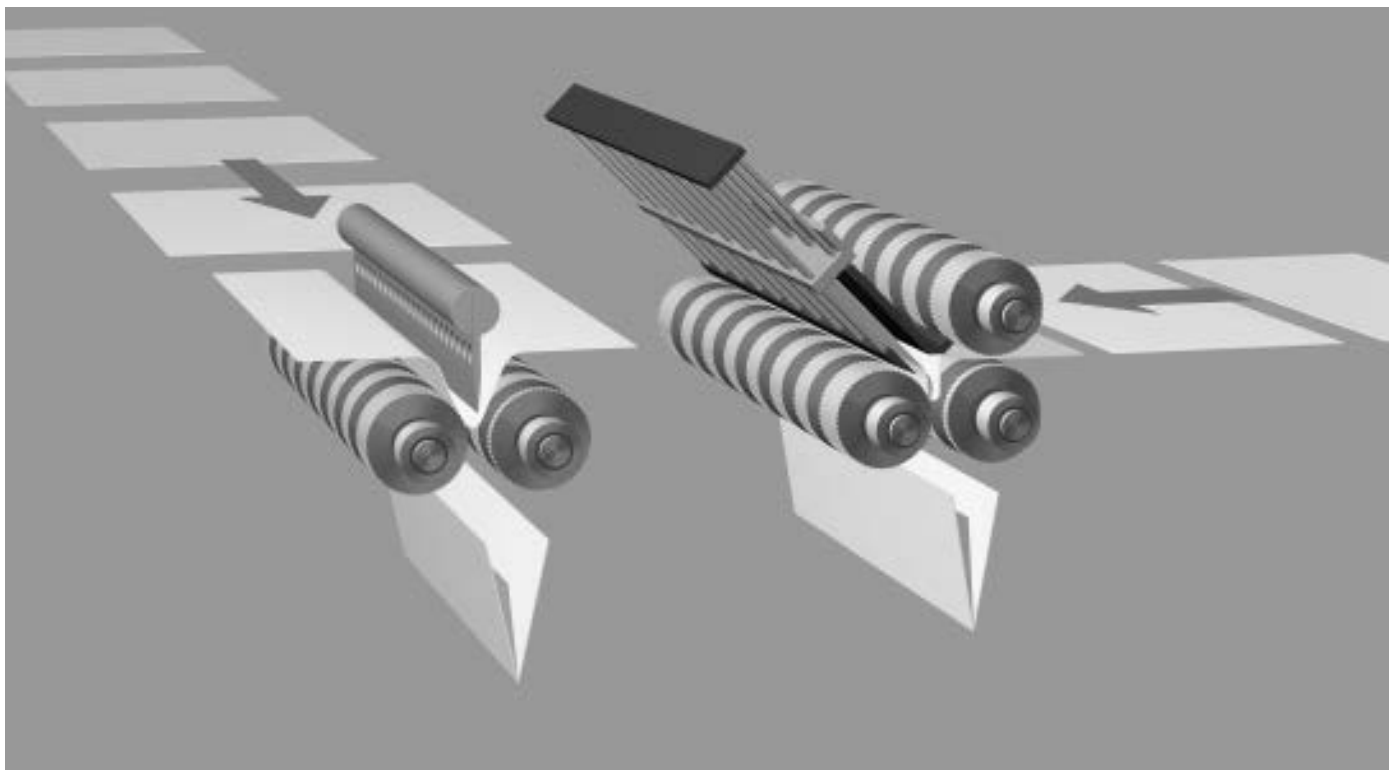

Two principles for the perfect fold.

You can configure our Heidelberg Stahlfolder folding machines to your individual requirements. What all the machines have in common, are the fold principles applied: the buckle plate and the knife fold principle.

Both processes have advantages. Pure buckle plate folding machines are characterized by great flexibility and offer maximum customizing. Combination folding machines have a smaller footprint and are made ready quickly.

The countless possibilities to configure a Stahlfolder folding machine give your creativity free rein and allow you to fold a variety of products. In order to maintain an overview, we have put together the most common fold types in this catalog.

Legend

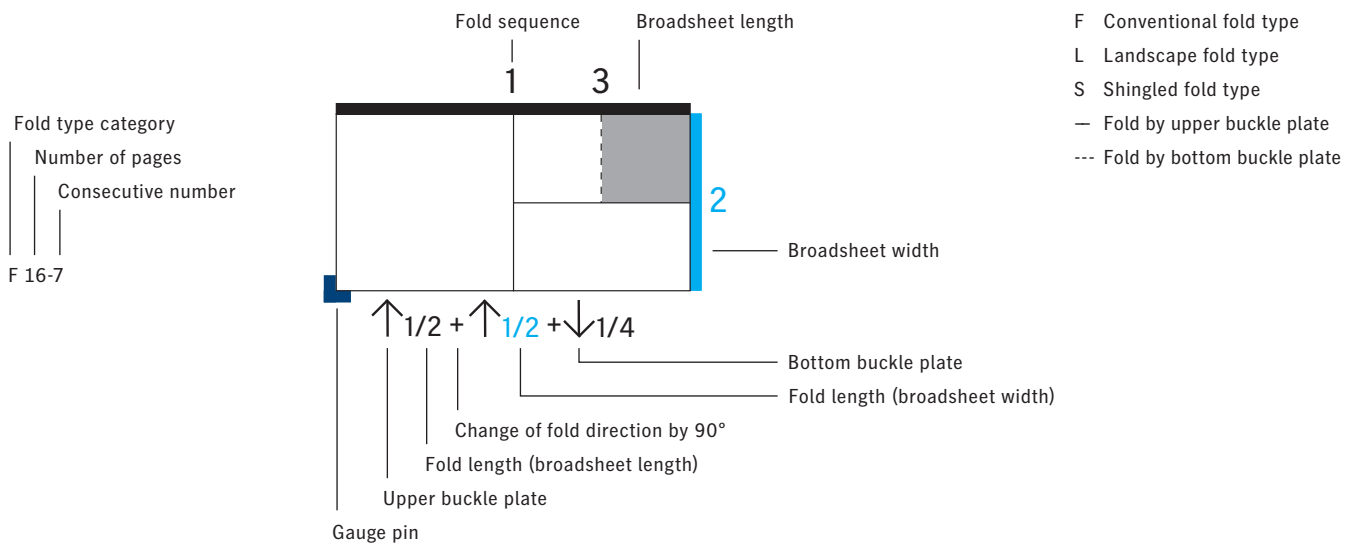

Conventional fold types

4-pager

F4-1

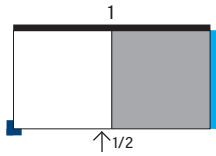

6-pager

F6-1

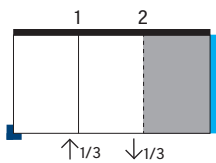

F6-2

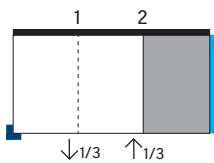

F6-3

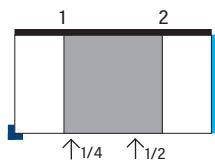

F6-4

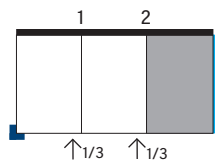

F6-5

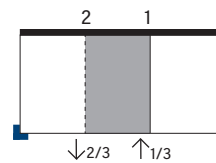

8-pager

F8-1

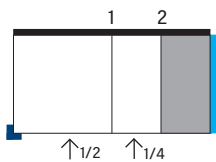

F8-2

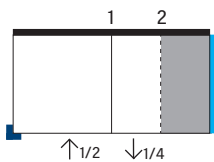

F8-3

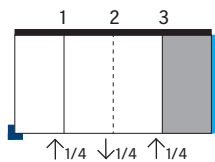

F8-4

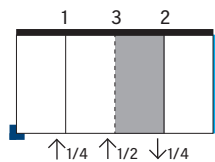

F8-5

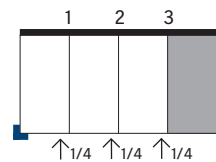

F8-6

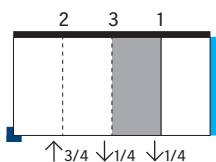

F8-7

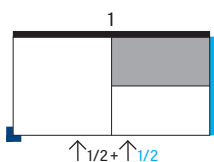

Conventional fold types

10-pager

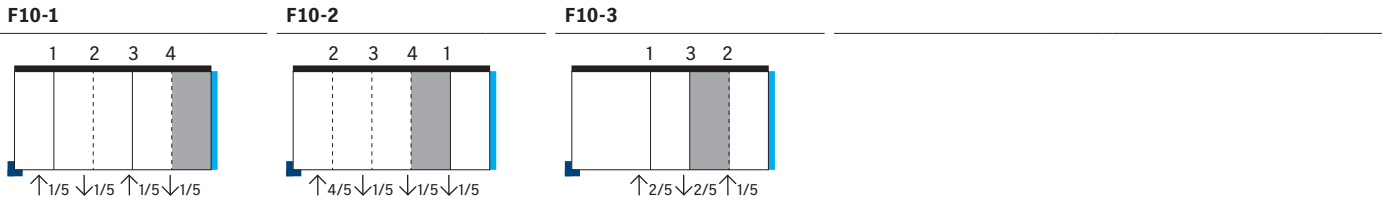

12-pager

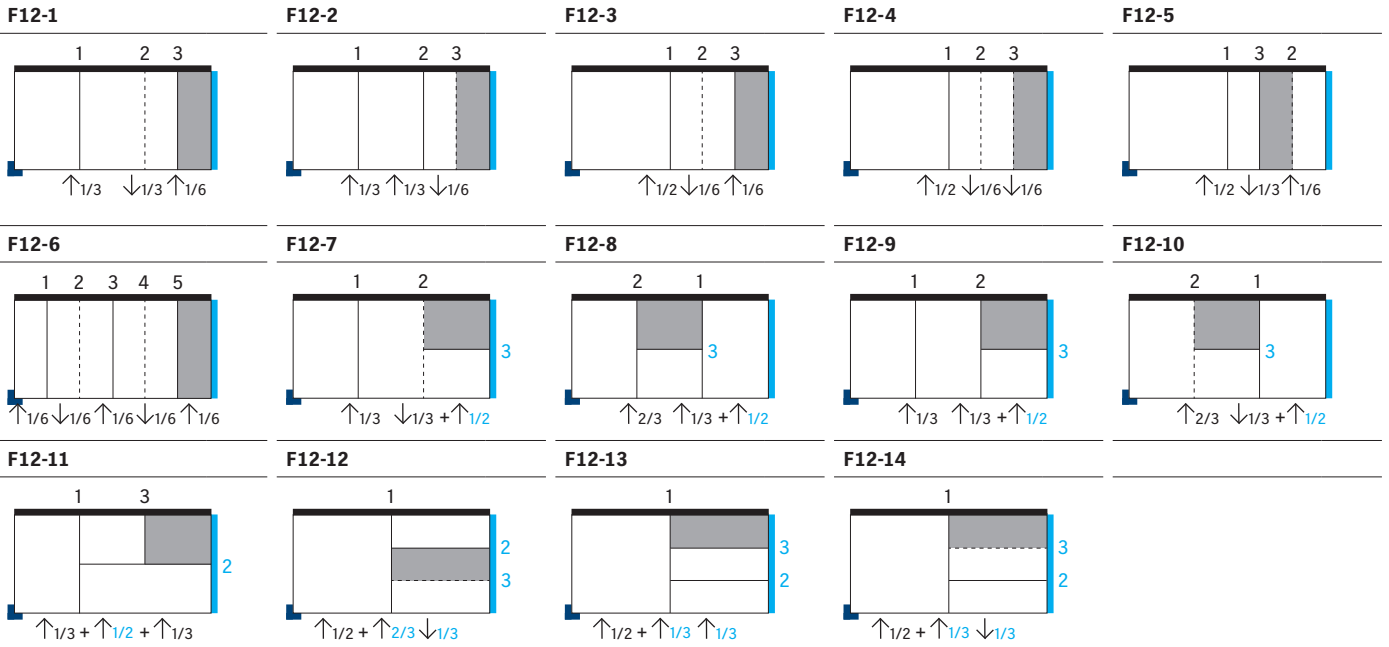

14-pager



16-pager

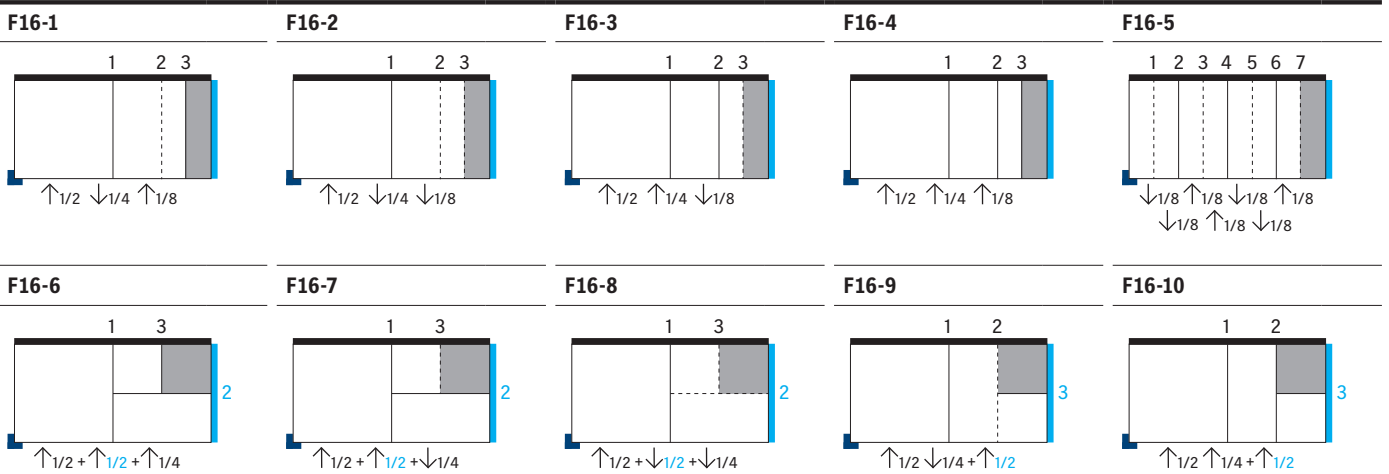

Conventional fold types

16-pager

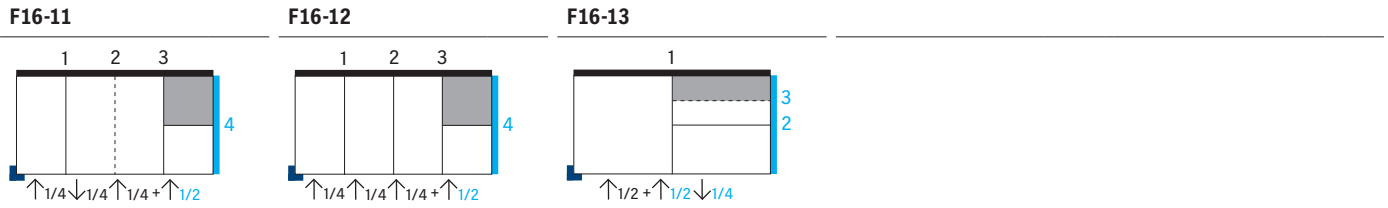

18-pager

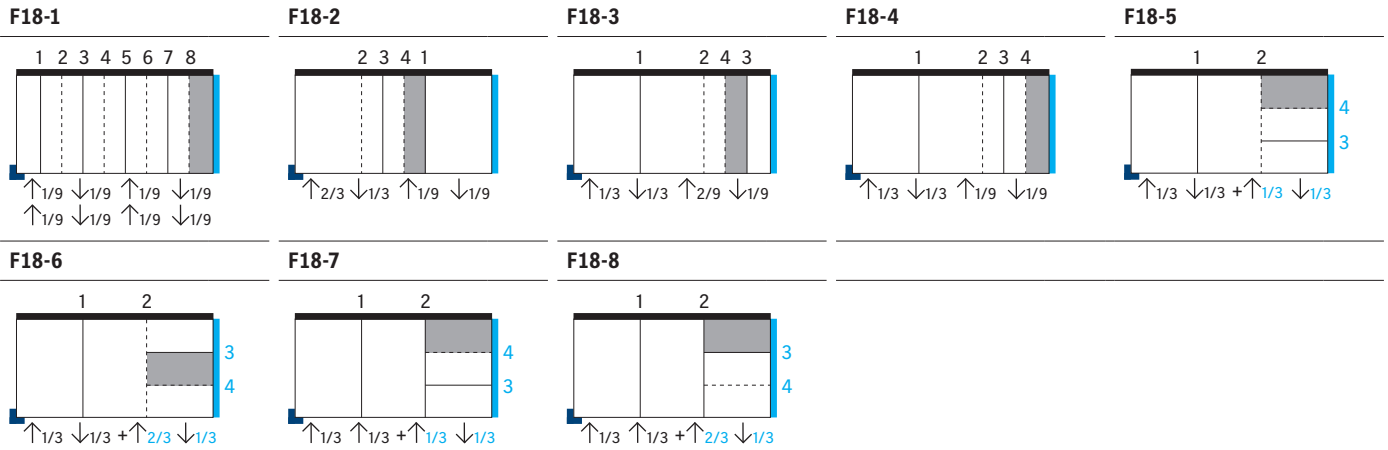

20-pager

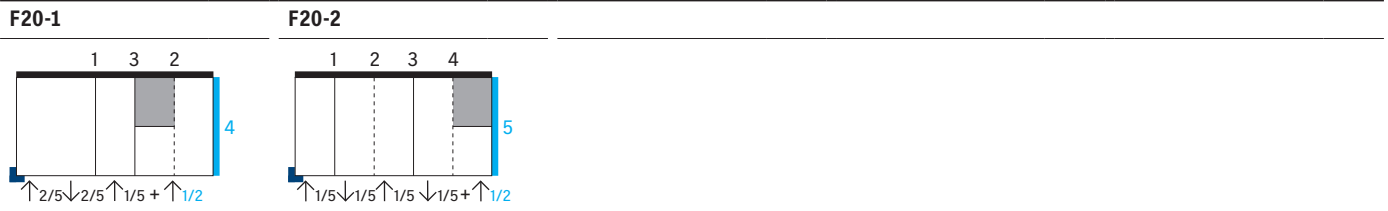

24-pager

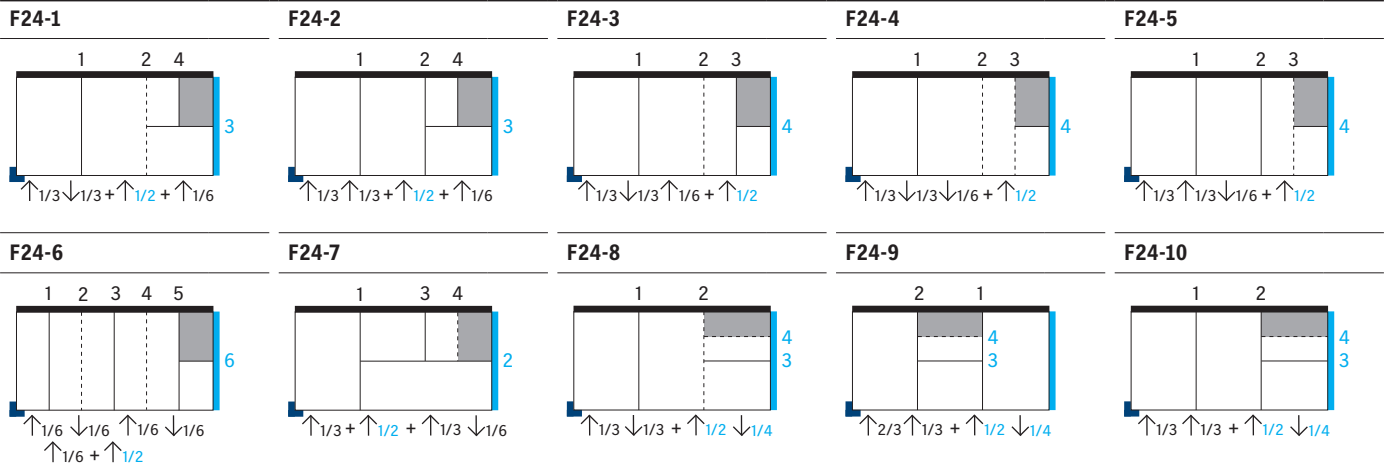

28-pager

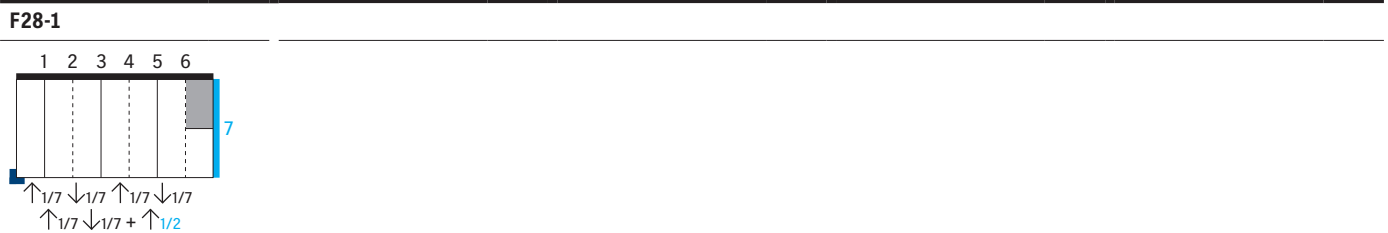

Conventional fold types

32-pager

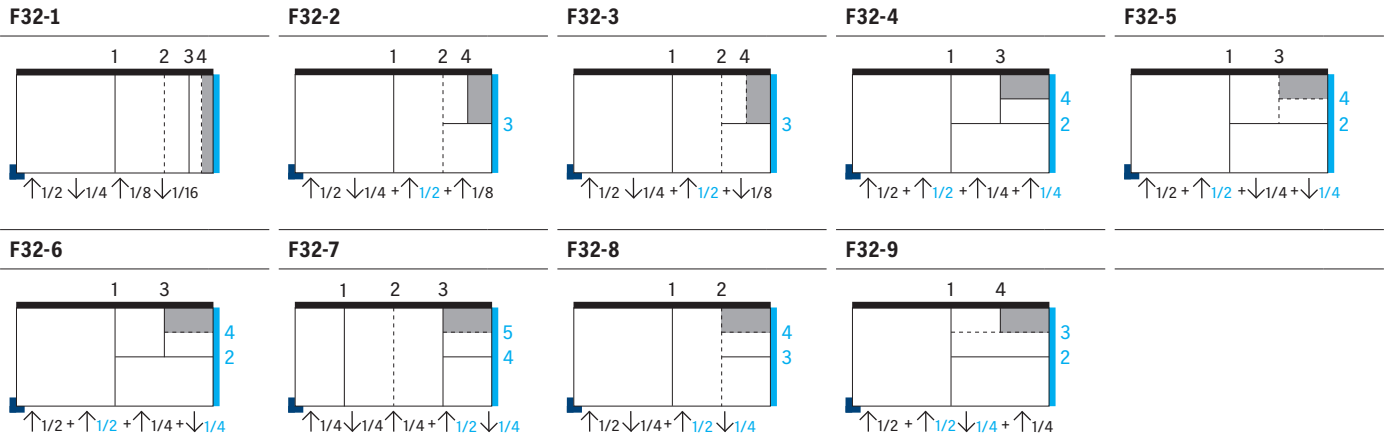

36-pager



40-pager



48-pager

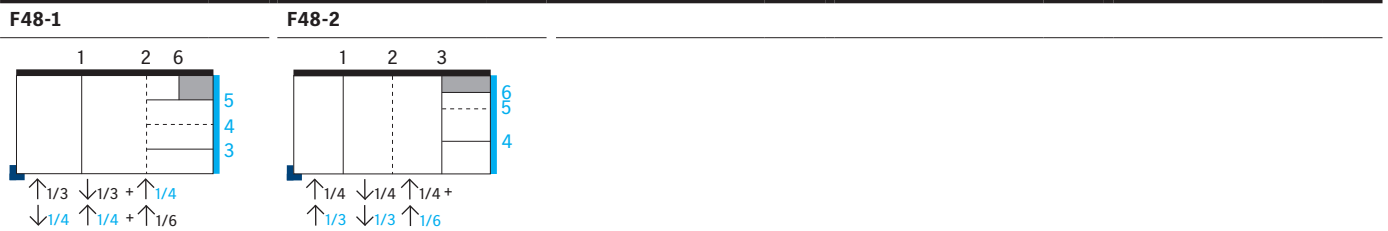

64-pager



Landscape fold types

16-pager

L16-1

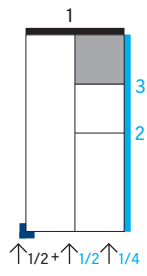

24-pager

L24-1

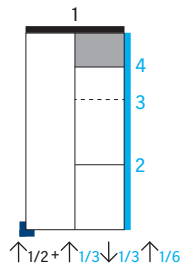

L24-2

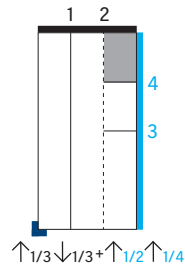

32-pager

L32-1

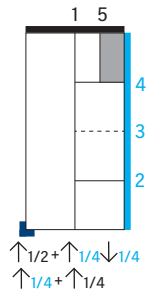

L32-2

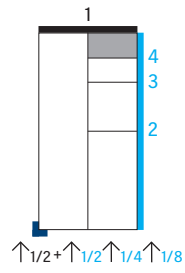

36-pager

L36-1

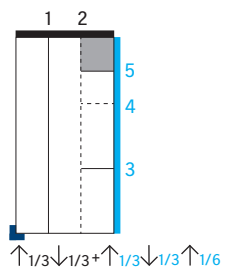

48-pager

L48-1

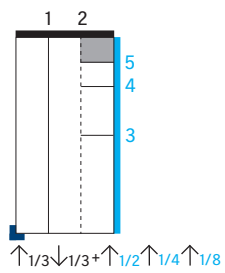

Shingled fold types

12-pager

S12-1

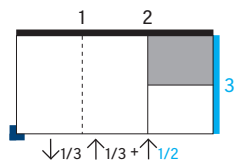

16-pager

S16-1

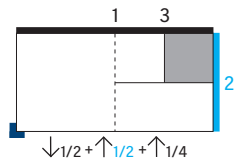

S16-2

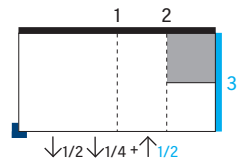

S16-3

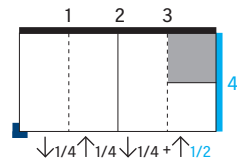

S16-4

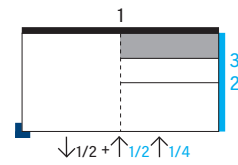

18-pager

S18-1

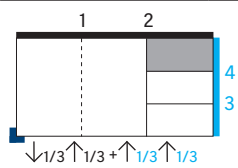

20-pager

S20-1

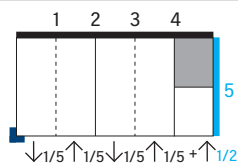

24-pager

S24-1

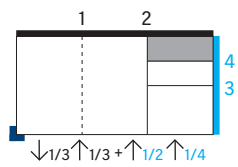

S24-2

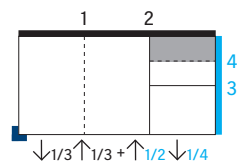

S24-3

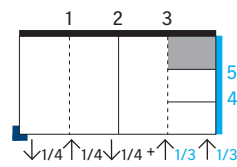

S24-4

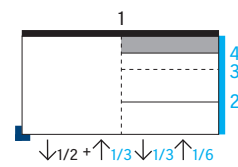

32-pager

S32-1

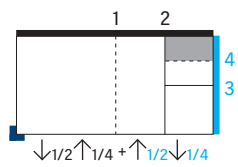

S32-2

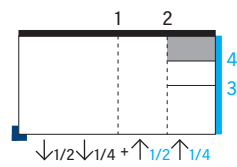

S32-3

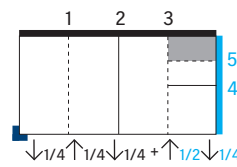

S32-4

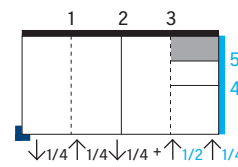

36-pager

S36-1

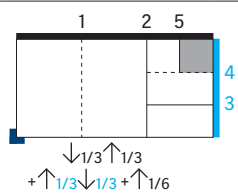

S36-2

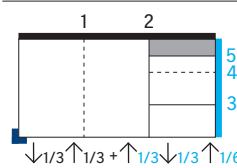

Shingled fold types

20-pager

S40-1

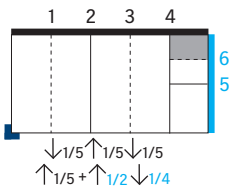

48-pager

S48-1

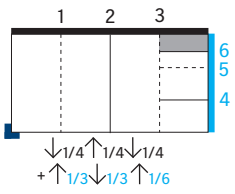

S48-2

